

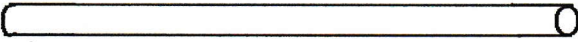









5X8M PVC PART LIST

Parts no.		Description	Qty
1		Frame pole ϕ 38mm	20
2		Frame pole ϕ 38mm	28
3		Support pole ϕ 38mm	10
4		Reinforce bar ϕ 25mm	10
5		Reinforce bar ϕ 25mm	5
15		Ground pole ϕ 38mm	6
6		110° 3-way joint	4
7		110° 4-way joint	6
8		140° 3-way joint	2
9		140° 4-way joint	3
10		Cross 4 Way joints	6
11		3 Way joints	4
12		Ground 3-way joint	4
13		Ground 3-way joint	6
14		Ground 2-way joint	4
17		Roof	1
18		End panel	2
19		Wall panel	8

I Place all joints , pipes No.1 and pipes No.2 on the ground as shown. Push two pipes into the joints, use screws fix them up.

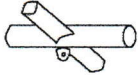
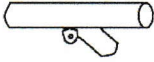
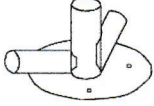
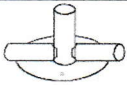
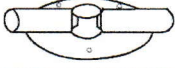
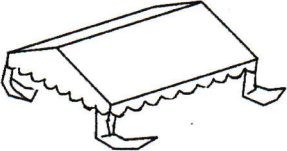

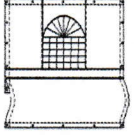
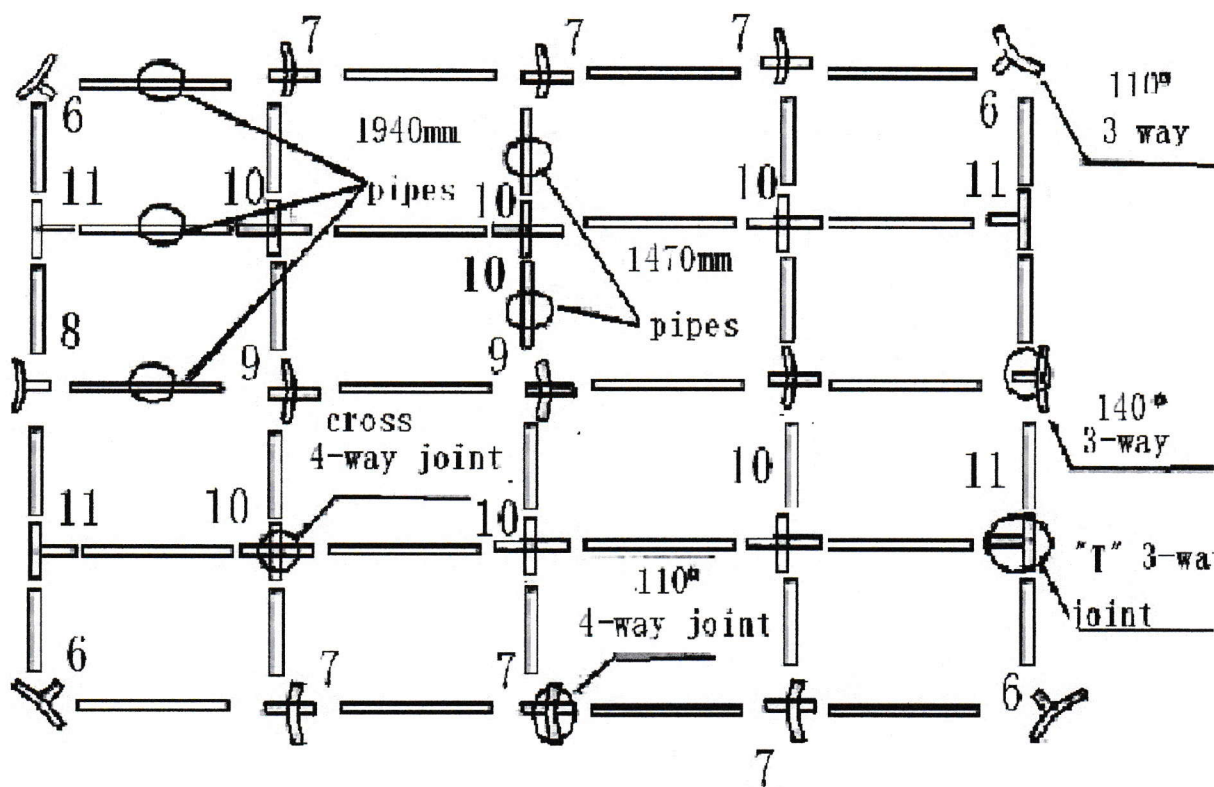
II Connect pipes together starting with the center frame. Then assemble each side.

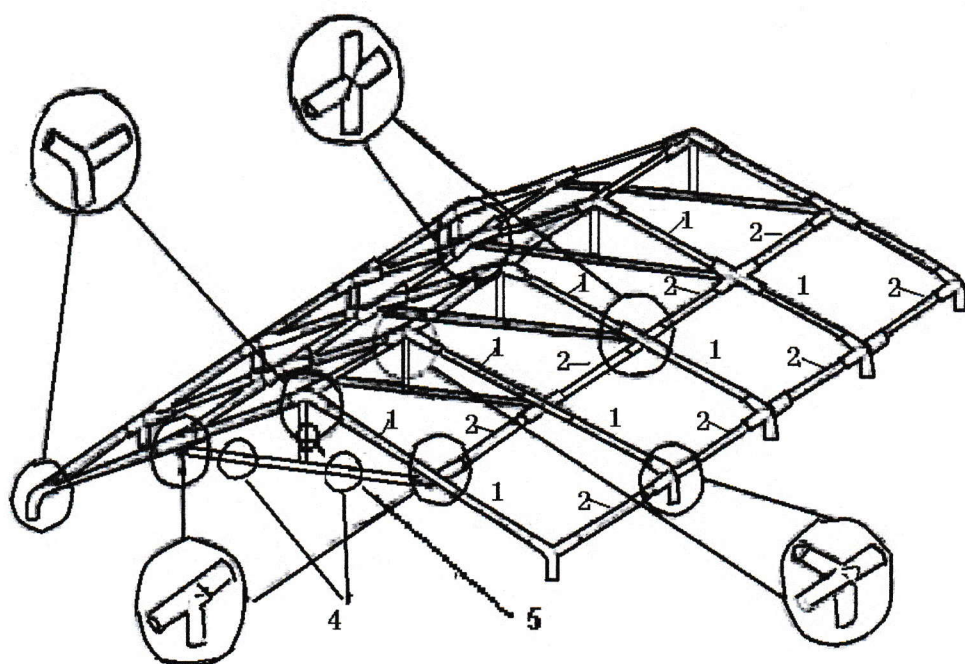

III Lift one side and connect pipe No.3 as leg.

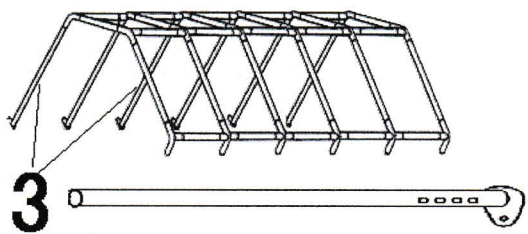

IV Place the cover over the frame.

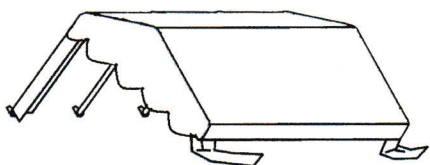

V Tie the bungee balls as picture to fix the roof on the frame.

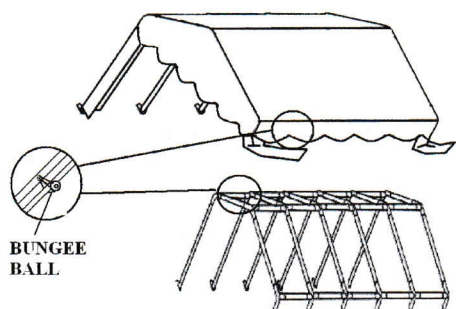

V Repeat step II lift another side.

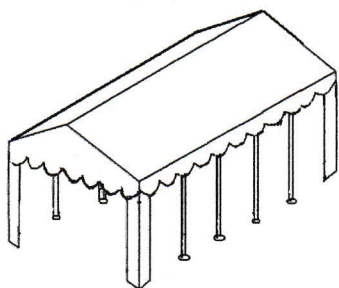

VI Then hung up all side panels, then install ground bars on legs..

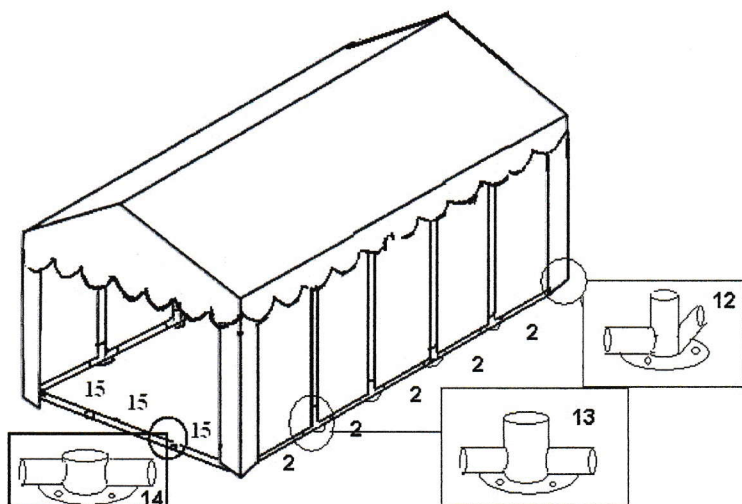

VI Use pegs and guy line to make tent more stable.

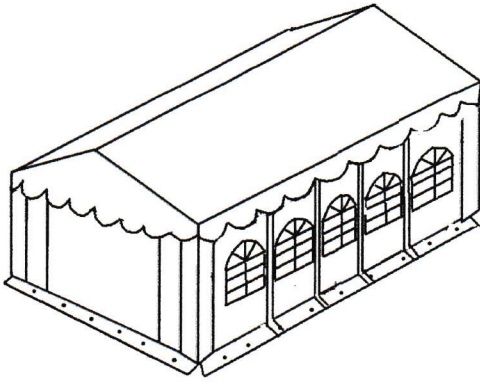

Warnung

1. Bitte achten Sie darauf, das Zelt vorsichtig zu behandeln, um Defekte zu vermeiden.
2. Das Gestänge nicht zu kräftig behandeln, da dies ansonsten Beschädigt werden könnte.
3. Zelte sind als temporäre Unterkunft gedacht und sollten bei widrigen Witterungsverhältnissen abgebaut werden.
4. Bitte wählen Sie immer einen geeigneten Abstand zu Schläuchen, Gas- oder Elektroleitungen, um diese nicht zu beschädigen.
5. Beim Einsatz geeigneter Heizgeräte (z. B. Auskunft im Fachhandel) ist ein Abstand von mindestens 1,2 m zu jeglichem Planenmaterial zu beachten. Offenes Feuer sowie Heizgeräte mit offenen Flammen wie Heizpilze, Terrassenstrahler, Gasheizer etc. sollten auf keinen Fall verwendet werden.
6. Der Aufbauer ist verantwortlich für die angemessene Verankerung und damit für die Sicherheit des Zeltes.